

Multi-User Operation in mmWave Wireless Networks

Michelle X. Gong, Dmitry Akhmetov, Roy Want

Intel Labs, Intel Corporation
Santa Clara, CA 95054-1549

Email: {michelle.x.gong, dmitry.akhmetov, roy.want}@intel.com

Shiwen Mao

Dept. ECE, Auburn University
Auburn, AL 36849-5201

Email: smao@ieee.org

Abstract—In this paper, we investigate the problem of multi-user spatial division multiple access (MU SDMA) operation in mmWave wireless networks, within which directional antennas are used to combat the high path-loss incurred in the 60GHz band. We study the feasibility of MU SDMA in mmWave networks and propose two MAC protocols to support CSMA/CA based uplink and downlink MU SDMA transmissions. The proposed protocols adopt virtual carrier sensing and allows multiple users to communicate with an access point (AP) simultaneously. Performance analysis and simulation results both show that the proposed protocols can achieve considerable performance improvements over a system that supports only single user (SU) operation.

I. INTRODUCTION

In recent years, the millimeter wave (mmWave) technology has attracted considerable interest from academia, industry, and standards bodies. This is due to the huge unlicensed bandwidth (i.e., up to 7GHz) that is available in the 60GHz band in most parts of the world. With this massive unlicensed bandwidth, many new bandwidth-demanding applications can be easily supported in a mmWave wireless local area network (WLAN).

A 60GHz signal has some unique propagation properties, including (i) high propagation loss even in free space and (ii) high attenuation loss due to obstacles [14]–[16]. For instance, a human body introduces at least 15dB loss to 60GHz signals compared to only 5dB loss to 5GHz signals. As a result, signals often travel through one predominant path in this band, while second-order and higher order reflections are highly attenuated [17]. While this property may be viewed as a problem in terms of coverage, it also gives us an exciting opportunity to maximize spatial multiplexing gain.

In mmWave systems, beamforming on both the receive and transmit side, is used to improve signal quality at the receiver. As a result of highly directional transmission and reception, the signal strength could be very low at third party stations that are not involved in the current exchange. By choosing stations that are not interfering with each other, an AP can form MU groups such that the AP can simultaneously transmit to and receive from stations (STAs) in the same MU group.

In our prior work [1], we proposed a directional Carrier Sense Multiple Access with Collision Avoidance (CSMA/CA)-based medium access protocol that is tailored for 60GHz wireless networks. Instead of relying on physical carrier

sensing, this protocol adopts virtual carrier sensing and relies on a central coordinator (e.g., the AP) to distribute Network Allocation Vector (NAV) information. However, the protocol proposed in [1] does not take advantage of spatial multiplexing gain in an mmWave network with directional transmissions. Due to the small interfering area of highly directional antennas, simultaneous communications in the same frequency channel and in the same physical space are indeed possible [2]. Therefore, a MAC protocol that takes advantage of the spatial reuse gain could effectively increase the aggregate network capacity.

In this paper, we propose two multi-user MAC protocols based on CSMA/CA, i.e. one uplink (UL) SDMA protocol and one downlink (DL) SDMA protocol. The MU MAC protocols retain the advantages of the previously proposed protocol and, moreover, enables spatial multiplexing in mmWave WLANs. Through MU beam-forming training, interference among different links is minimized. Then, the AP assigns non-interfering links into the same MU group. Since links in the same MU group do not interfere with each other while operating in the directional mode, the AP can simultaneously transmit to and receive from multiple stations (STAs) in the same MU group. Such concurrent transmissions will improve the system throughput performance.

We present an analysis based on a Markov Chain model of the MU SDMA system, which is used to derive the system saturation throughput and the optimal transmission probability for a station (STA). We also implement the proposed protocols in OPNET Modeler and evaluate its performance with simulations. Both analytical and simulation results demonstrate that the proposed MU MAC protocols achieve considerable throughput gains over the 802.11 MAC.

The remainder of this paper is organized as follows. We first discuss related work in Section II. We then introduce the system model and the DL/UL MU MAC protocols in Section III. An analysis of the proposed protocols and our simulation study are presented in Sections IV and V, respectively. Section VI concludes this paper.

II. RELATED WORK

Several standards have been or are being defined to achieve multi-gigabit rates for 60GHz wireless networks, such as ECMA-387 [4], IEEE 802.15.3c [5], and IEEE

802.11ad cite80211ad. All three standards focus on using Time Division Multiple Access (TDMA) for data communications. Existing MAC protocols recently proposed for 60GHz networks [6], [7] are also based on TDMA. Because data traffic is bursty, the required medium time is often highly unpredictable. A TDMA-based MAC protocol may cause either high overhead for on-the-fly medium reservation, or under- or over-allocated medium time for individual users. Furthermore, because scheduling is computationally intensive and should be executed in real time, it is challenging to implement such scheduling algorithms on a mobile station.

Contention-based MAC protocols, such as CSMA/CA, work well with bursty traffic and operate robustly in unlicensed bands [3]. However, the conventional CSMA/CA protocol does not work well with directional antennas due to impaired carrier sensing at transmitters. Many contention-based MAC protocols that support directional antennas have been proposed for mobile ad hoc networks or wireless mesh networks [8]–[11]. A short survey of directional MAC protocols can be found in [12]. Ref. [18] describes in more detail why many existing directional MAC protocols cannot be directly applied in the 60GHz band.

There has been prior work that studied the benefit of SDMA in WLANs [17], [19], [20], [22]–[24]. While most of the SDMA work focus on lower frequency bands, such as 2.4GHz band and 5GHz band, there have been studies on the capacity of 60GHz networks. [20] studies the capacity of a 60GHz system when using single input multiple output (SIMO), multiple input single output (MISO), and multiple input multiple output (MIMO) configurations. The authors observed that the system capacity improves significantly if 16 or 64 antenna elements are used at both terminal antennas instead of the basic SISO configuration. However, [20] studied only the single user capacity. Yiu and Singh [17] studied the empirical capacity of mmWave WLANs when SDMA is utilized. The authors studied the performance difference between linear array and circular array and discovered that if linear antenna arrays are utilized, a maximum aggregated rate of 9 Gbps can be obtained.

Our work differs from these papers in the following ways: 1) our work focuses on protocol design to support SDMA operation in 60GHz networks while [17], [20] focus on the capacity study and 2) we propose two CSMA/CA based MAC protocols while [17] assumes a TDMA based system.

III. PROTOCOL DESCRIPTION

In this section, we describe two CSMA/CA-based MAC protocols to support MU operation in 60GHz WLANs and explain how the proposed protocol exploits spatial multiplexing gain to improve network throughput.

A. System Model

We consider a wireless LAN in which there is one AP that coordinates medium access for multiple STAs. The AP also provides basic timing and manages membership of the network. A unique challenge in the design of 60GHz wireless

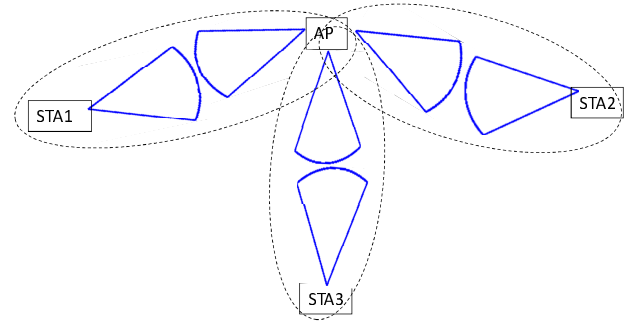

Fig. 1. Illustration of the MU transmission scheme.

networks arises from the requirement for high antenna gain at both the transmitter and receiver. However, before two stations can finish beam-forming training with each other, neither one can achieve proper beam-formed transmission or reception. Therefore, a low-rate modulation and coding scheme (MCS) needs to be defined to address the case when only one end of the link has high beam-forming gain. To this end, we assume a range optimized MCS, i.e. MCS0, which has a receiver sensitivity about 12dB higher than that of a data rate optimized MCS that offers data rates higher than 1 Gbps. Many existing directional contention-based MAC protocols assume that normal data rate can be maintained even when only one end of the link uses directional antennas. This assumption is not valid anymore in the 60GHz band. In 60GHz, MCS0 has to be used for beam-forming training and, moreover, for transmissions when only one end of the link has high antenna gain.

After a multi-user beam-forming training procedure is completed, the AP can group STAs into different MU groups such that the AP can transmit to all STAs in the same MU group simultaneously and STAs in each group introduce negligible interference to each other when they're transmitting simultaneously. The AP assigns one multi-cast address to each MU group. A frame transmitted to the multicast address is addressed to all STAs in the same MU group. As illustrated in Fig. 1, the AP can simultaneously transmit to and receive from all STAs in one MU group.

B. Multi-User CSMA/CA Protocols

We describe the DL and UL CSMA/CA MAC protocols in this section. With these two protocols, a STA always beam-forms towards the AP in its idle mode (i.e., waiting to receive), meaning there is high receive antenna gain. While idle, the AP receives in its omni mode, meaning that there is no significant receive antenna gain. Because a STA is always beam-formed towards the AP before any data transmission or reception and the AP coordinates the transmission within a WLAN, the deafness problem is thus easily solved [18]. Before any data transmission, a handshake is performed between the AP and the designated STA using Request-to-Send (RTS) and a variant of Clear-to-Send (CTS).

To describe the downlink (DL) MU protocol operation, we

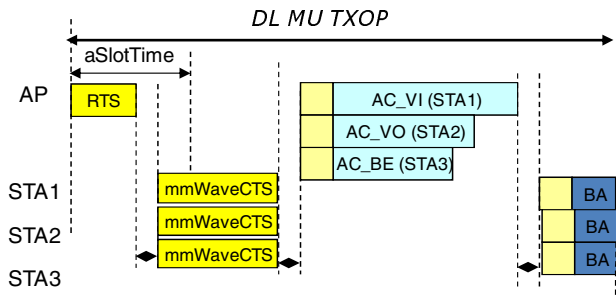

Fig. 2. DL MU operation, UL MU is also supported.

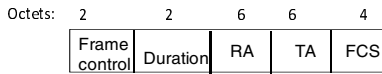

Fig. 3. An mmWave CTS.

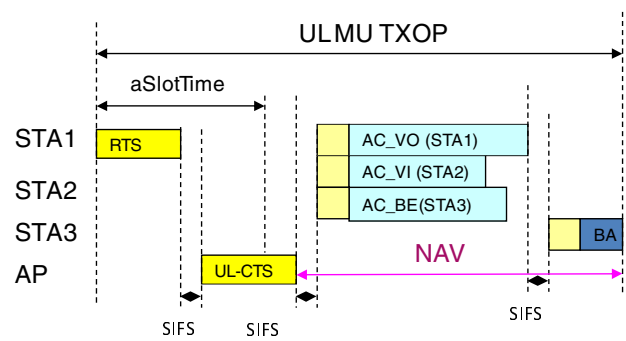

Fig. 4. UL MU operation.

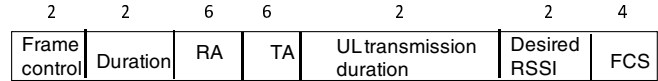

Fig. 5. A UL CTS.

consider a typical scenario shown in Fig. 1. In this scenario, STA1, STA2, and STA3 can transmit to and receive from the AP simultaneously. In the idle mode, all stations are beam-formed towards the AP. As illustrated in Fig. 2, the AP transmits an RTS frame using quasi-omni transmission. The receive address (RA) of the RTS frame is the multi-cast address associated with an MU group. All STAs in the WLAN will receive the RTS frame but only STAs that belong to the MU group identified by the multi-cast address replies with an mmWaveCTS. The mmWave CTS contains both RA and transmit address (TA) as shown in Fig. 3. Both RTS and mmWaveCTS are transmitted using MCS0 because only one end of the link has beam-forming gain.

In this example, because UL MU operation is also supported, the AP can receive mmWaveCTS from multiple STAs. If UL MU operation is not supported, the AP can transmit a RTS to one selected STA in the MU group as described in [19] and receive one CTS from the selected STA. Upon receiving multiple mmWaveCTS frames or a CTS frame, the AP transmits buffered traffic to STAs belong to the same MU group using directional transmission. The buffered traffic destined to different STAs may belong to the same or different access categories (AC). The IEEE 802.11 spec defines four different access categories to support and prioritize traffic with different QoS requirements [13]. They are video access category (AC_VI), voice access category (AC_VO), best effort access category (AC_BE), and background access category (AC_BK). In the example given in Fig. 3, the traffic destined for STA1 is AC_VI, the traffic destined for STA2 is AC_VO, and the traffic destined for STA3 is AC_BE. Data frames destined for different STAs may have different length. However, the maximum length of the DL MU burst is included in the data frame header so that all STAs that receive the DL MU burst know when to reply with a block ack (BA). If UL MU operation is supported, all three STAs may reply with a BA at the same time. Otherwise, a scheduled response scheme or a polled response scheme can be used as described in [19].

The operation of the UL MU protocol is illustrated in Fig. 4.

Before STA1 transmits a data frame, it transmits an RTS frame to the AP. The duration field of the RTS frame indicates the duration of the intended data transmission from STA1. Upon receiving the RTS frame, the AP may transmit an Uplink Clear To Send (UL-CTS) message in quasi-omni mode. This ensures that all associated STAs can receive it. As shown in Fig. 5, the UL-CTS frame contains the following fields: Duration field, Receive Address (i.e. the multicast address of a MU group), Transmit Address (i.e. AP), and a field that describes the desired received signal strength indicator (RSSI) at the AP. The duration field indicates the maximum duration allowed for the subsequent UL data transmission, the multicast RA indicates that all STAs belong to the MU group can transmit in the current Transmission Opportunity (TXOP), the desired RSSI field provides an indication of the desired receive power at the AP. The desired RSSI field can be used for transmit power adjustment at the STAs. Both RTS and UL-CTS are transmitted using MCS0 because only one end of the link has beam-forming gain. If the AP does not receive the RTS either due to channel error or a collision on RTS, STA1 will not receive a UL-CTS after transmitting an RTS. Thus, STA1 assumes that a collision has occurred and starts an exponential backoff procedure.

After receiving a UL-CTS and recognizing it belongs to the MU group identified in the multicast address, a STA transmits its buffered traffic to the AP. If a STA does not have buffered traffic for this TXOP, it can transmit a QoS-Null frame. Within the maximum duration indicated in the UL-CTS frame, a STA can transmit one or more Aggregate MAC Protocol Data Units (A-MPDUs) at a high data rate [13]. Upon receiving the UL A-MPDUs, the AP replies with Block ACK (BA) frames, each of which identifies which MPDUs in the corresponding A-MPDU have been received successfully.

Because all STAs are beam-formed towards the AP and the width of the beam generated by an antenna array is narrow, most other STAs won't be able to receive the RTS sent from the source STA. Therefore, for a third-party STA to

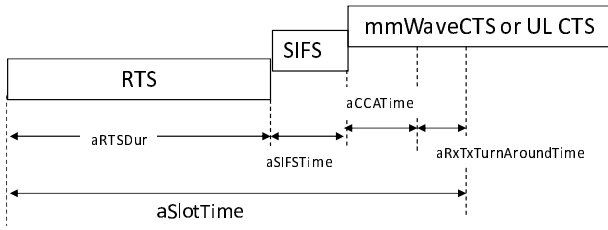

Fig. 6. The definition of aSlotTime in the proposed protocol.

detect an on-going transmission, virtual carrier sensing has to be used and thus aSlotTime needs to include aRTSDur and aSIFSTime. The definition of aSlotTime in the proposed protocol is illustrated in Fig. 6.

aSlotTime is set to:

$$\begin{aligned} aSlotTime &= aRTSDur + aSIFSTime + aCCATime + \\ & aRXTxTurnAroundTime, \end{aligned}$$

where aRTSDur is the duration of a RTS frame, which includes the PHY preamble, the PHY header and the RTS frame body. aSIFSTime is a short inter-frame time between receiving a packet and sending out an acknowledgement. aCCATime is the time that a receiver needs to determine whether a valid packet is on the medium. aRXTxTurnaroundTime is the time that a half-duplex station needs to switch from Rx mode to Tx mode.

IV. PERFORMANCE ANALYSIS

In this section, we present an analytical study of the proposed MU MAC protocols. We derive the saturation throughput of the proposed protocols, which is defined as the throughput level achieved at the top of the MAC layer when all nodes in the systems are continuously loaded.

It is assumed that stations use MAC frame aggregation schemes, such as A-MPDU, and may make multiple transmissions in one TXOP. When TXOP is utilized, a station or an AP contends once to transmit an RTS. Upon successful reception of at least one mmWaveCTS or a UL-CTS that allows a station to transmit, the station or the AP can transmit as many A-MPDUs as the TXOP duration permits, provided that the last BA can be received within the TXOP duration.

We follow the assumptions made in [3] and adopt the same 2-D Markov chain model for the proposed MAC protocol. In the Markov chain mode, each state is represented by $\{s(t), b(t)\}$, where $s(t)$ is defined to be the stochastic process representing the backoff stage $\{0, \dots, m\}$ of the station at time t and $b(t)$ is the stochastic process representing the back-off time counter for a given station. The maximum backoff stage, i.e., m , takes the value such that $CW_{max} = 2^m CW_{min}$, where CW_{max} is the maximum contention window and CW_{min} is the minimum contention window.

Let S be the normalized system throughput, defined as the fraction of time the channel is used to successfully transmit payload bits. S can be expressed as the average number of

payload bits transmitted in a TXOP divided by the average length of a TXOP. Based on the 2-D Markov chain model, we derive the system saturation throughput as:

$$\begin{aligned} S &= P_{AP} \frac{P_s P_{tr} \sum_{j=1}^M \sum_{i=1}^{N_j} \mathbb{E}[P_{ij}]}{(1 - P_{tr})\sigma + P_{tr} P_s T_{ds} + P_{tr}(1 - P_s)T_c} + \\ & P_{STA} \frac{P_s P_{tr} \sum_{j=1}^M \sum_{i=1}^{N_j} \mathbb{E}[P_{ij}]}{(1 - P_{tr})\sigma + P_{tr} P_s T_{us} + P_{tr}(1 - P_s)T_c}, \end{aligned} \quad (1)$$

where

$$\begin{cases} T_{us} = \sigma + aULCTSDur + TXOP \\ T_{ds} = \sigma + ammWaveCTSDur + TXOP \\ T_c = \sigma \\ P_{tr} = 1 - (1 - \tau)^2 \\ P_s = \frac{n\tau(1-\tau)^{n-1}}{1 - (1-\tau)^n}. \end{cases} \quad (2)$$

In the above equations, P_{AP} is the probability that an AP wins the contention, P_{STA} is the probability that a STA wins the contention, M is the number of STAs which an AP can simultaneously transmit to and receive from, T_{us} is the average time consumed by a successful UL TXOP, T_{ds} is the average time consumed by a successful DL TXOP, T_c is the average medium time a collision consumes, σ is the duration of a time slot, aULCTSDur is the transmission duration of the UL-CTS frame, amWaveCTSDur is the transmission duration of the mmWaveCTS frame, τ is the probability that a station transmits in a randomly chosen time slot, n is the number of contending devices in the network, including the AP and the stations, P_s is the probability that a TXOP is successfully set up, and P_{tr} is the probability that there is at least one transmission in the considered slot time. The sum $\sum_{j=1}^M \sum_{i=1}^{N_j} \mathbb{E}[P_{ij}]$ is the combined average payload size of A-MPDUs that are transmitted in the TXOP.

The optimal contention window is derived as follows:

$$W_{opt} = n\sqrt{\frac{2T_c}{\sigma}} = n\sqrt{2}. \quad (3)$$

As illustrated in Fig. 7, the optimal contention window size increases linearly with the number of contending STAs.

Because the mmWaveCTS frame and the UL-CTS frame are similar in length, we can approximate T_{us} with T_{ds} . Without differentiating downlink or uplink TXOP, Eqn. (1) can be rearranged as follows:

$$S = \frac{\sum_{j=1}^M \sum_{i=1}^{N_j} \mathbb{E}[P_{ij}]}{T_s - T_c + \frac{(1-\tau)}{n\tau}\sigma + T_c \frac{1-(1-\tau)^n}{n\tau(1-\tau)^{n-1}}}, \quad (4)$$

where T_s is approximately the same for either uplink or downlink TXOP. Under condition $\tau \ll 1$, τ can be estimated as [3]

$$\tau \approx \frac{1}{n\sqrt{T_c/(2\sigma)}}. \quad (5)$$

In Fig. 8, we plot the optimal saturation throughput of MU SDMA when the AP can support 3 simultaneous streams and the number of stations in the WLAN. The optimal saturation throughput increase linearly with the number of STAs in the

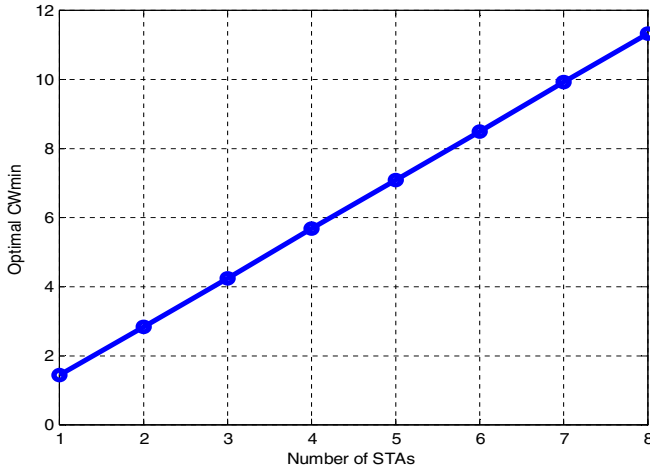

Fig. 7. Optimal CWmin vs. number of STAs.

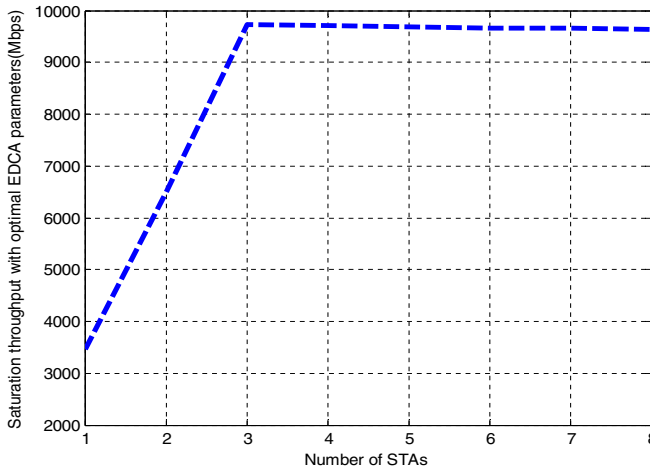

Fig. 8. Optimal saturation throughput vs. number of STAs in the WLAN.

network until there are more than three contending STAs in the network.

V. SIMULATION STUDY

We evaluate the performance of the proposed MU MAC protocol with OPNET simulations. Our simulation uses a typical WLAN topology with one AP and a variable number of stations in the network. For each STA in the network, there is bi-directional UDP traffic between the AP and the STA. The simulation parameters and their values are given in Table I. We adopted the living room channel model defined in the IEEE 802.11 TGad [21]. The distance between the AP and the clients is about 1.5 meters. The simulation results are presented in Fig. 9 and Fig. 10.

As shown in Fig. 9, when both DL and UL SDMA are supported, the saturation throughput achieved by the proposed MU MAC protocols increases linearly with an increase in the number of STAs in the network until the number of streams reaches the maximum number of streams that an AP can support simultaneously. These results match the analytical results shown in Fig. 8 very well. Furthermore, the maximum

TABLE I
SIMULATION PARAMETERS

Parameter	Value	Parameter	Value
MCS0 Rate (Mbps)	25	aSlotTime (us)	20
Data Rate (Mbps)	3800	aSIFSTime (us)	3
ACK Rate (Mbps)	1650	TXOP duration (us)	500
A-MPDU size (byte)	65,536	MCS0 preamble (us)	3.75
RTS/mmWaveCTS (byte)	26	Data preamble (us)	1.75
UL-CTS (byte)	24	Default CWmin	15
BA size (byte)	32	Default CWmax	1023

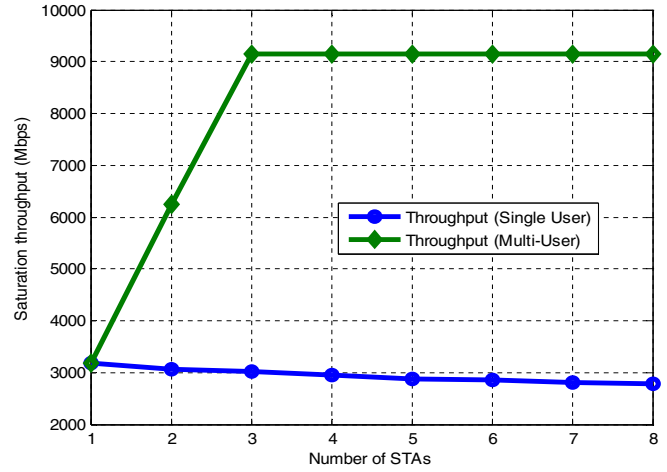

Fig. 9. Aggregate saturation throughput (Combined UL and DL SDMA vs Single User)

saturation throughput a network can achieve is about 9.1Gbps when the AP can support 3 streams simultaneously. This is about three times higher than the throughput achieved by the directional CSMA/CA protocol without MU support.

The simulation results for the DL SDMA only case are presented in Fig. 10. If only DL SDMA is supported at the AP and the AP can support 3 streams simultaneously, the saturation throughput increases with the number of downlink streams until there are more than 3 DL streams in the network. Note that when only DL SDMA is supported, the increase in throughput is not as significant. This is because by allowing multiple STAs to transmit simultaneously, UL SDMA can effectively reduce the number of collisions and increase transmission probability for each STA. On the other hand, DL SDMA does not improve each STA's transmission probability because AP is the only node that transmits DL traffic.

VI. CONCLUSION

We proposed and evaluated two CSMA/CA based MU MAC protocols for mmWave WLANs. The proposed MU MAC protocols utilize spatial diversity in a network with highly directional antennas. Through analysis and OPNET simulations, we find that the proposed protocols achieve significantly higher throughput than the SU directional CSMA/CA protocol presented in our prior work. If both DL and UL SDMA are supported in a network, the throughput increases linearly with

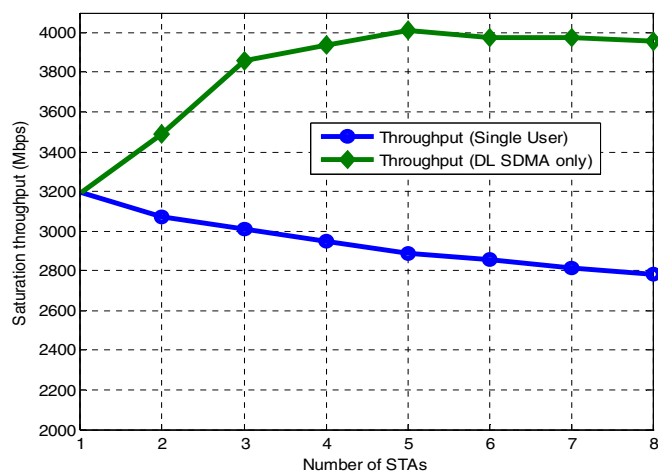

Fig. 10. Aggregate saturation throughput (DL SDMA only vs. Single User).

the number of STAs in the network until the number of streams reach the maximum number of streams that an AP can support simultaneously. Simulation results also show that if more than one STA are present in the network, UL SDMA offers higher throughput gain than DL SDMA because UL SDMA increases transmission probability for each STA by allowing multiple STAs to transmit simultaneously.

ACKNOWLEDGMENT

Shiwen Mao's research is supported in part by the US National Science Foundation (NSF) under Grants ECCS-0802113, CNS-0953513 and CNS-0855251, and through the Wireless Internet Center for Advanced Technology (WICAT) at Auburn University. Any opinions, findings, and conclusions or recommendations expressed in this material are those of the author(s) and do not necessarily reflect the views of the NSF.

REFERENCES

- [1] M. Gong, R. Stacey, A. Dmitry, and S. Mao, "A directional CSMA/CA protocol for mmWave wireless PANs," in *Proc. IEEE WCNC'10*, Sydney, Australia, Apr. 2010, pp.1–6.
- [2] R. Mudumbai, S. Singh and U. Madhow, "Medium access control for 60 GHz outdoor mesh networks with highly directional links," in *Proc. IEEE INFOCOM'09*, Rio de Janeiro, Brazil, Apr. 2009, pp.2871–2875.
- [3] G. Bianchi, "Performance analysis of the IEEE 802.11 Distributed Coordination Function," *IEEE J. Sel. Areas Commun.*, vol.18, no.3, pp.535–547, Mar. 2000.
- [4] ECMA TC48, ECMA standard 387, "High Rate 60GHz PHY, MAC and HDMI PAL," Dec. 2008.
- [5] IEEE 802.15 WPAN Task Group, "3c millimeter wave alternative PHY (TG3c)," [online] Available: <http://www.ieee802.org/15/pub/TG3c.html>.

- [6] X. An and R. Hekmat, "Directional MAC protocol for millimeter wave based wireless personal area networks," in *Proc. IEEE VTC-Spring'08*, Singapore, May 2008, pp.1636–1640.
- [7] C.-W. Pyo, F. Kojima, J. Wang, H. Harada, and S. Kato, "MAC enhancement for high speed communications in the 802.15.3c mmWave WPAN," *Springer Wireless Pers. Commun.*, vol.51, no.4, pp.825–841, July 2009.
- [8] M. Takai, J. Martin, A. Ren, and R. Bagrodia, "Directional virtual carrier sensing for directional antennas in mobile ad hoc networks," in *Proc. ACM MobiHoc'02*, Lausanne, Switzerland, June 2002, pp.183–193.
- [9] J. Hsu and I. Rubin, "Performance analysis of directional CSMA/CA MAC protocol in mobile ad hoc networks," in *Proc. IEEE ICC'06*, Istanbul, Turkey, June 2006, pp.3657–3662.
- [10] Y.B. Ko, V. Shankarkumar, and N.H. Vaidya, "Medium access control protocols using directional antennas in ad hoc networks," in *Proc. IEEE INFOCOM'00*, Tel Aviv, Israel, Mar. 2000, pp.13–21.
- [11] T. Korakis, G. Jakllari, and L. Tassiulas, "A MAC protocol for full exploitation of directional antennas in ad-hoc wireless networks," in *Proc. ACM MobiHoc'03*, Annapolis, MD, June 2003, pp.98–107.
- [12] M. X. Gong, S. Midkiff, and S. Mao, "MAC protocols for wireless mesh networks," in *Wireless Mesh Networking: Architectures, Protocols and Standards*, Y. Zhang, J. Luo, and H. Hu (Editors), pp.147–182. New York, NY: Auerbach Publications, 2006.
- [13] IEEE standard 802.11, "Wireless LAN Medium Access Control (MAC) and Physical Layer (PHY) specification," 2007.
- [14] C.P. Lim, R.J. Burkholder, J.L. Volakis, and R. J. Marhefka, "Propagation modeling of indoor wireless communications at 60 GHz," in *Proc. IEEE Antennas and Propagation Society International Symposium*, Albuquerque, NM, July 2006, pp.2149–2152.
- [15] M. Marcus and B. Pattan, "Millimeter wave propagation: spectrum management implications," *IEEE Microwave Mag.*, vol.6, no.2, pp.54–62, June 2005.
- [16] C.R. Anderson and T.S. Rappaport, "In-building wideband partition loss measurements at 2.5 and 60 GHz," in *IEEE Trans. Wireless Commun.*, vol.3, no.3, pp.922–928, May 2004.
- [17] C. Yiu and S. Singh, "Empirical capacity of mmWave WLANs," in *IEEE J. Sel. Areas Commun.*, vol.27, no.8, pp.1479–1487, Oct. 2009.
- [18] M.X. Gong, D. Akhmetov, R. Want, and S. Mao, "Directional CSMA/CA protocol with spatial reuse for mmWave wireless networks," in *Proc. IEEE GLOBECOM 2010*, Miami, FL, Dec. 2010, pp.1–5.
- [19] M.X. Gong, E. Perahia, R. Stacey, R. Want, and S. Mao, "A CSMA/CA MAC protocol for multi-user MIMO wireless LANs," in *Proc. IEEE GLOBECOM 2010*, Miami, FL, Dec. 2010, pp.1–6.
- [20] A. Arvanitis, G. Anagnostou, N. Moraitis, and P. Constantinou, "Capacity study of a multiple element antenna configuration in an indoor wireless channel at 60GHz," in *IEEE VTC-Spring'07*, Dublin, Ireland, Apr. 2007, pp.609–613.
- [21] A. Maltsev, et. al, "Channel models for 60GHz WLAN systems," *IEEE 11-09-0334-08-00ad-channel-models-for-60ghz-WLAN-systems*, IEEE 802.11 Meeting, May 2010.
- [22] Y. Choi, N. Lee, and S. Bahk, "Exploiting multi-user MIMO in the IEEE 802.11 wireless LAN systems," *Wireless Personal Commun.*, vol.54, no.3, pp.385–396, May 2009.
- [23] L.X. Cai, et al., "A distributed multi-user MIMO MAC protocol for wireless local area networks," *Proc. IEEE GLOBECOM'08*, New Orleans, LA, Nov./Dec. 2008, pp.1–5.
- [24] M. Zhao, M. Ma, and Y. Yang, "Applying opportunistic medium access and multiuser MIMO techniques in multi-channel multi-radio WLANs," *J. Mobile Netw. Appl.*, vol.14, no.4, pp.486–507, Aug. 2009.