

(a)

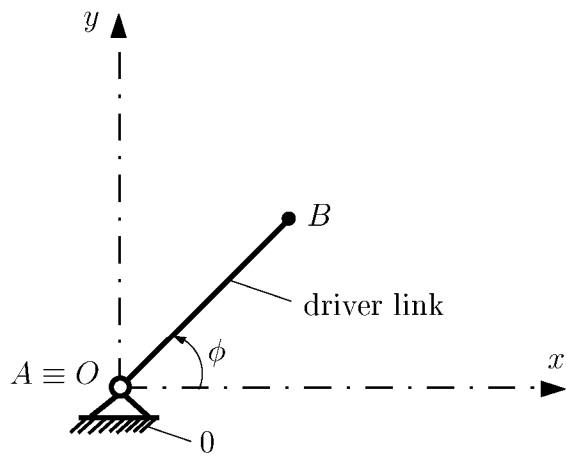

(b)

Fig. 1

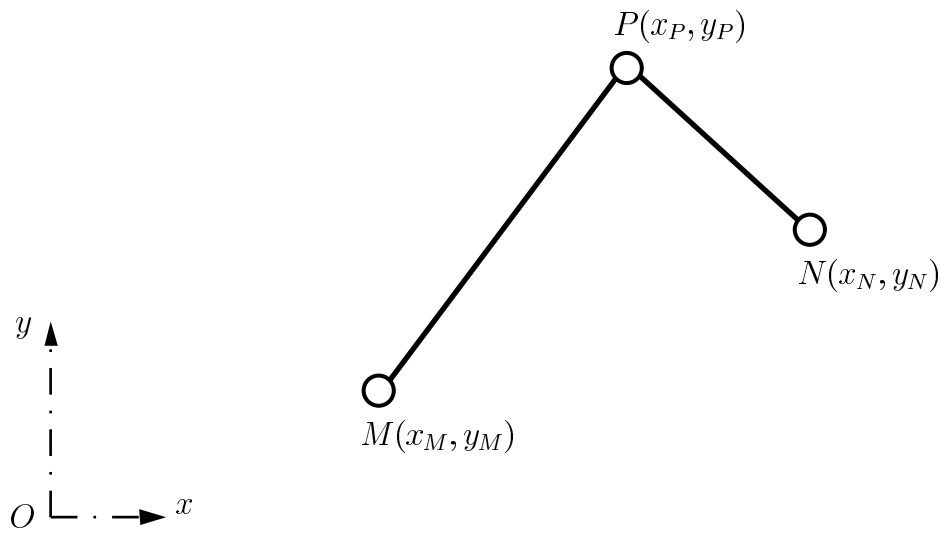

(a)

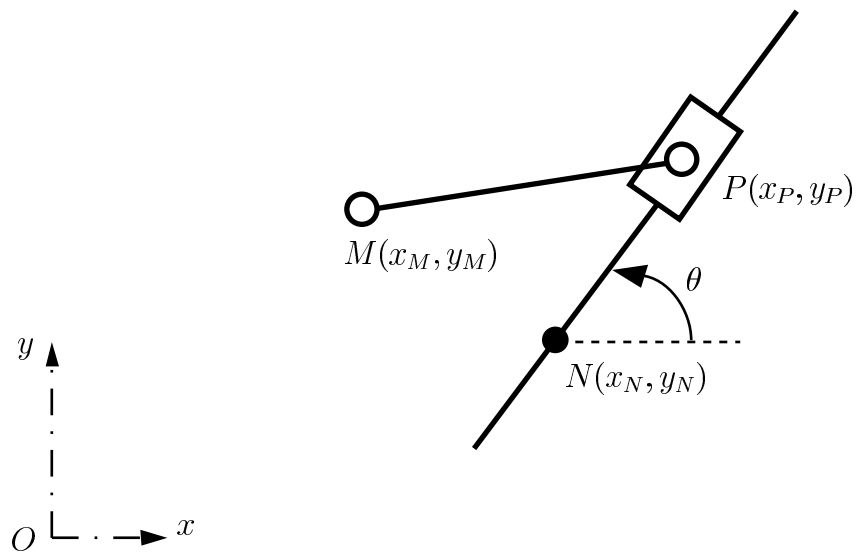

(b)

Fig. 2

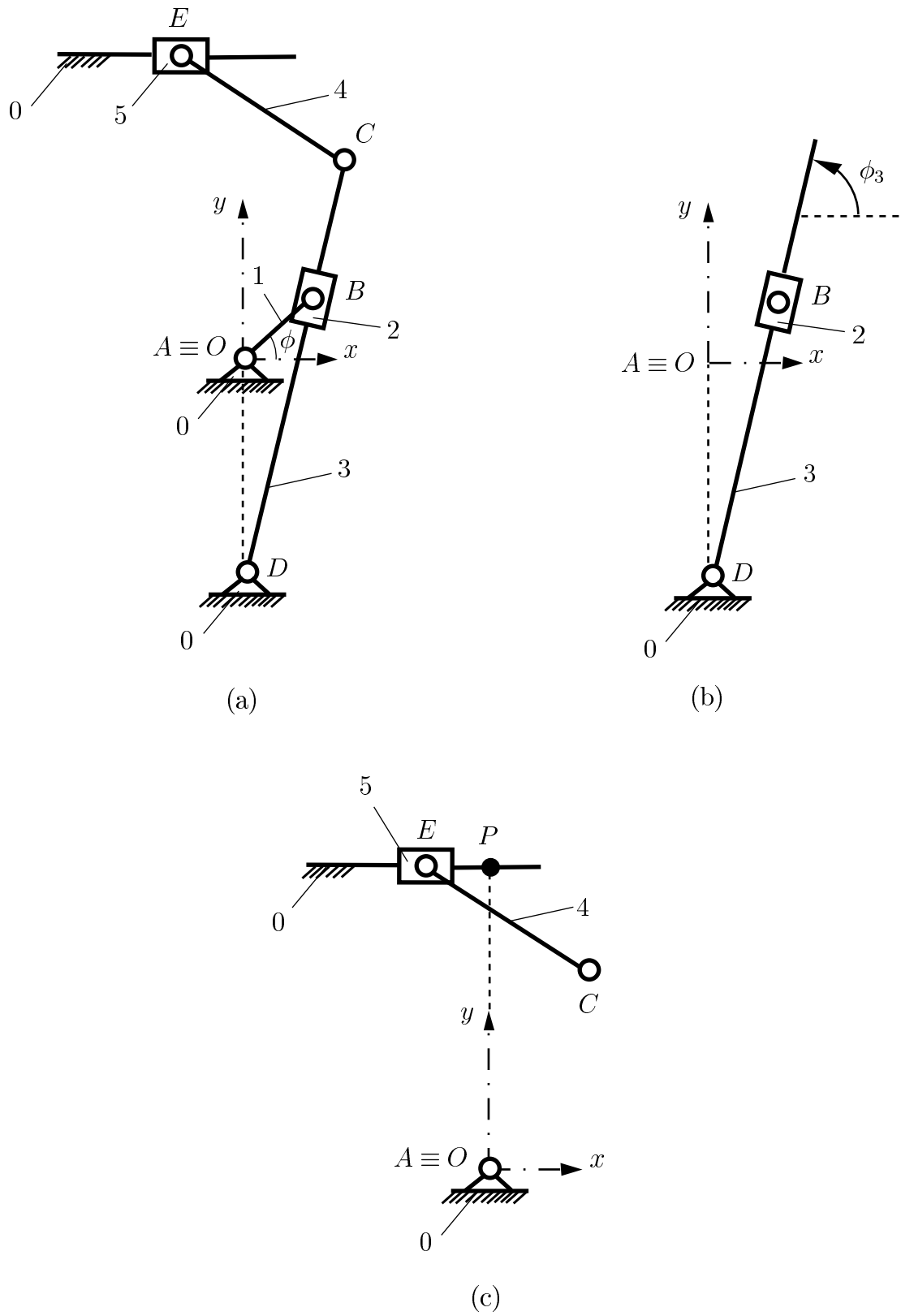
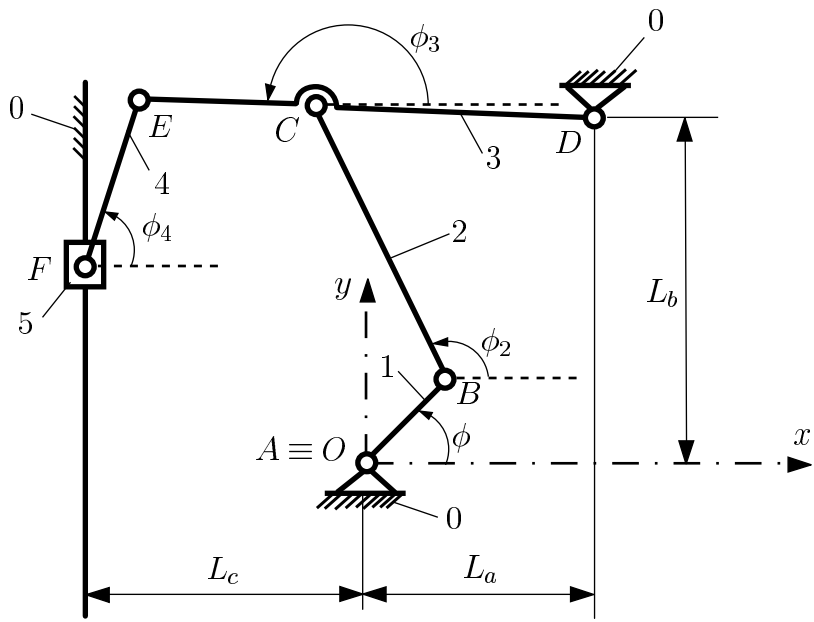
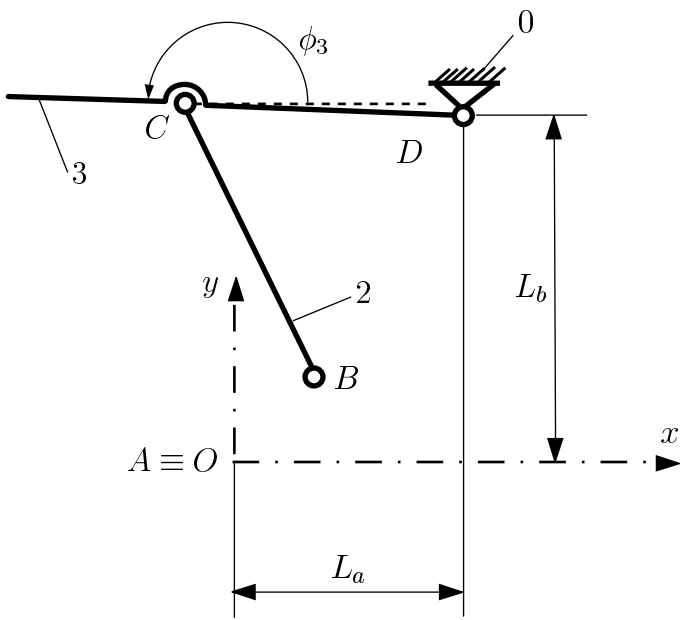

Fig. 3



(a)



(b)

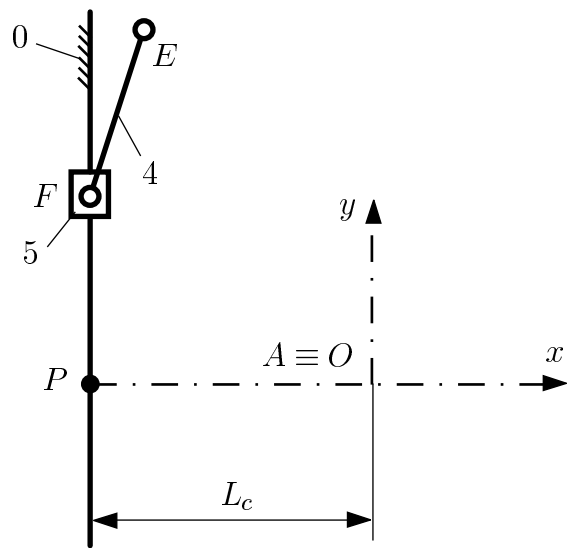

(c)

Fig. 4

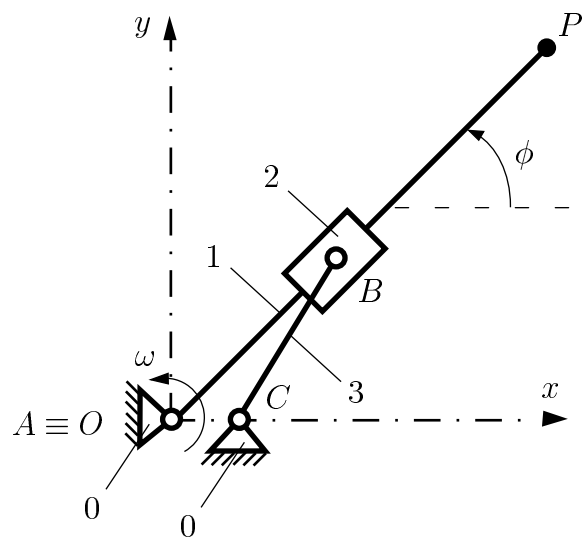

Fig. 5

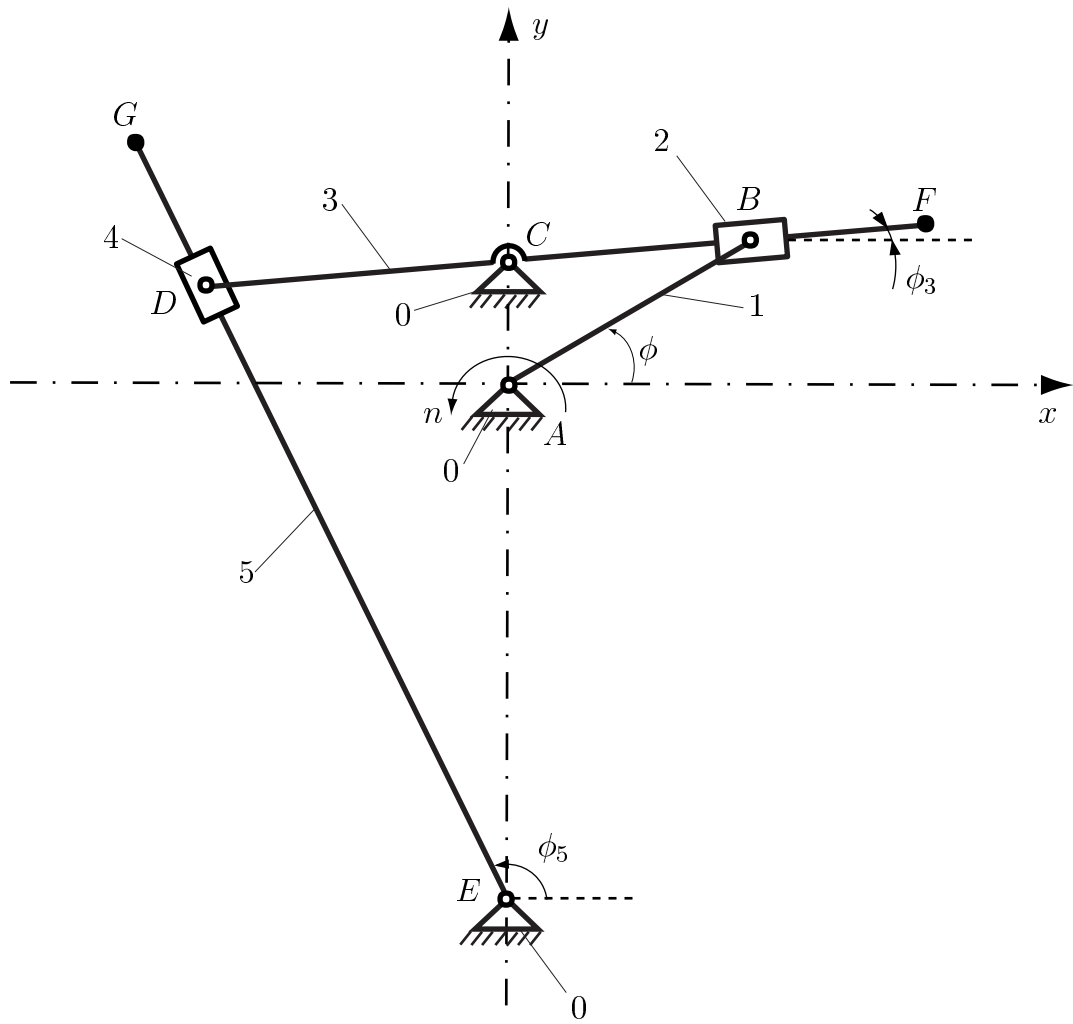

Fig. 6

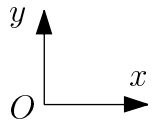
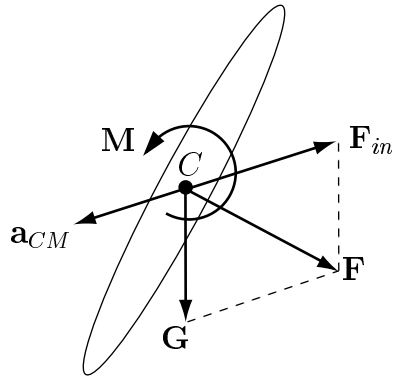

Fig. 7

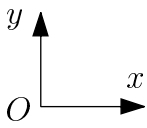
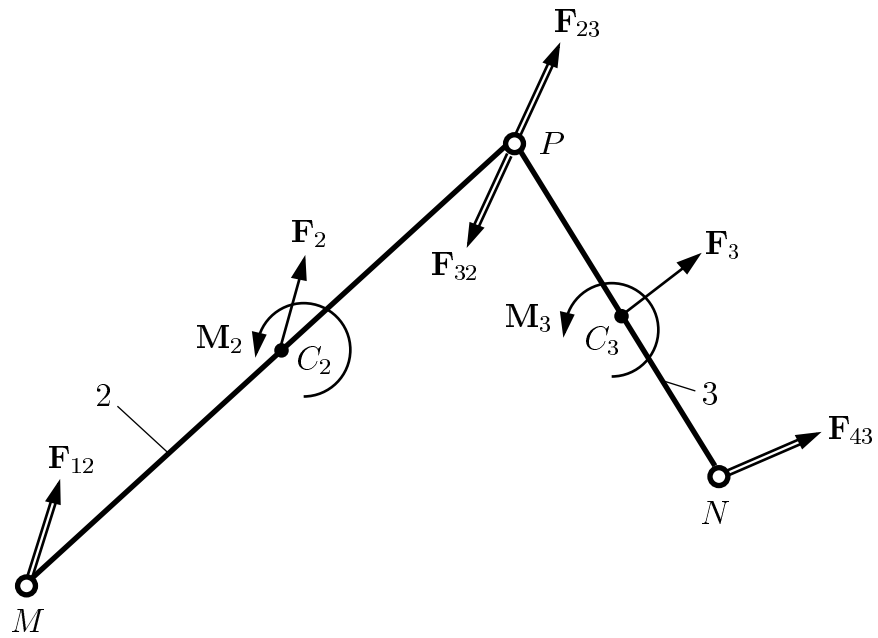

Fig. 8

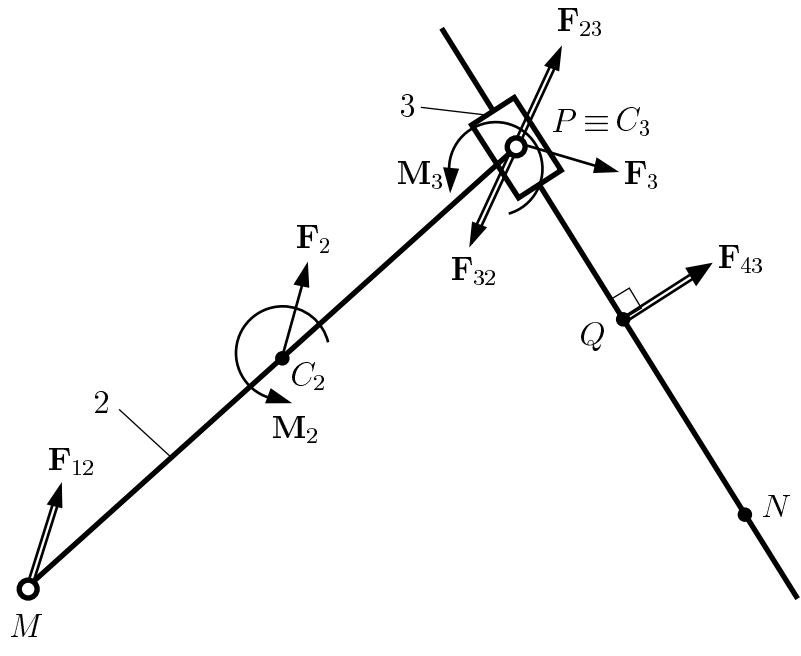

Fig.9

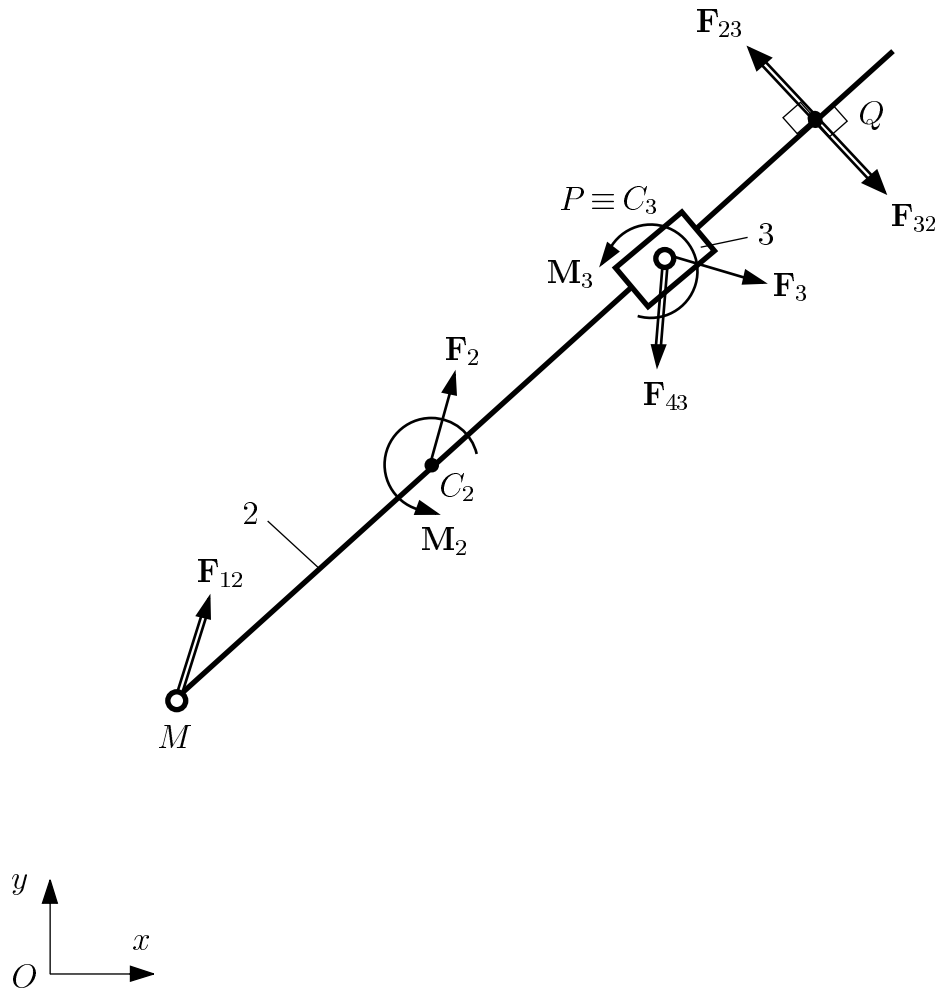

Fig. 10

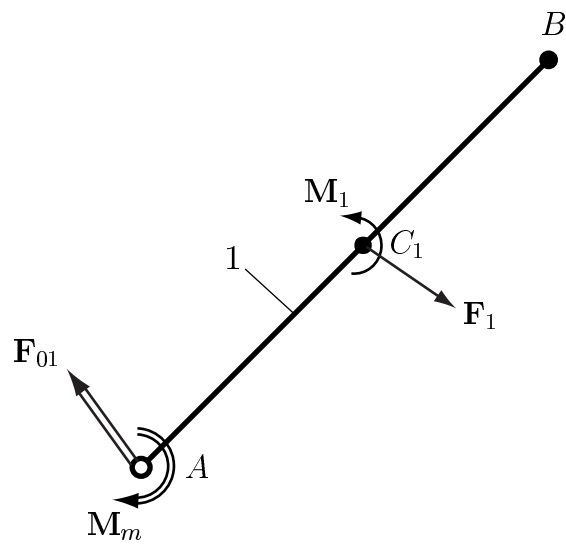
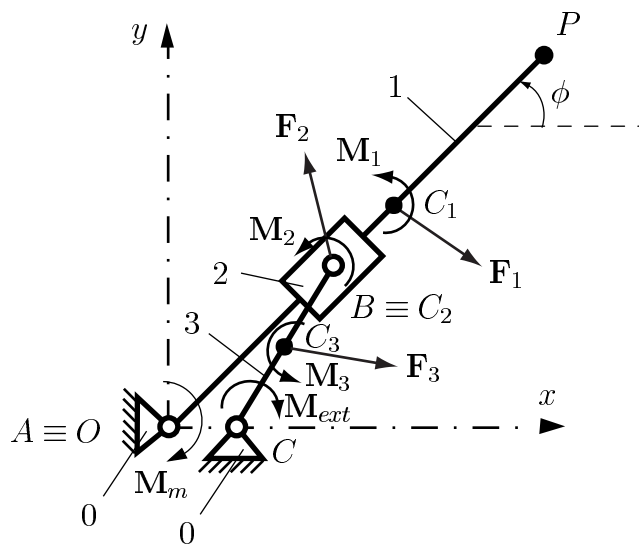
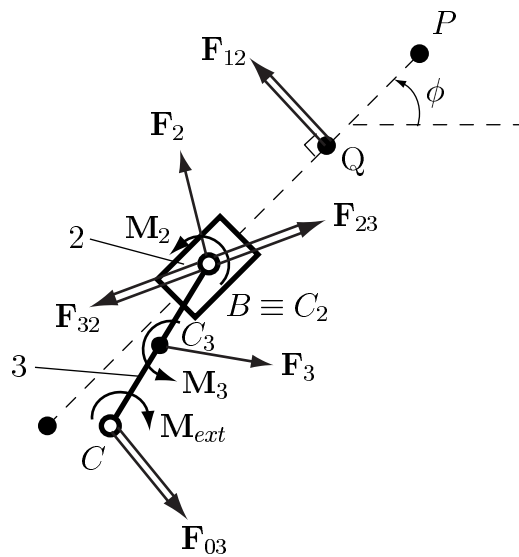

Fig. 11

(a)



(b)



(c)

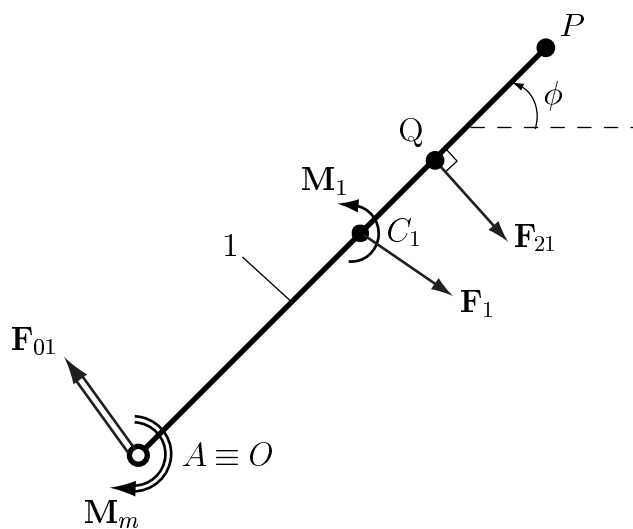

Fig. 12

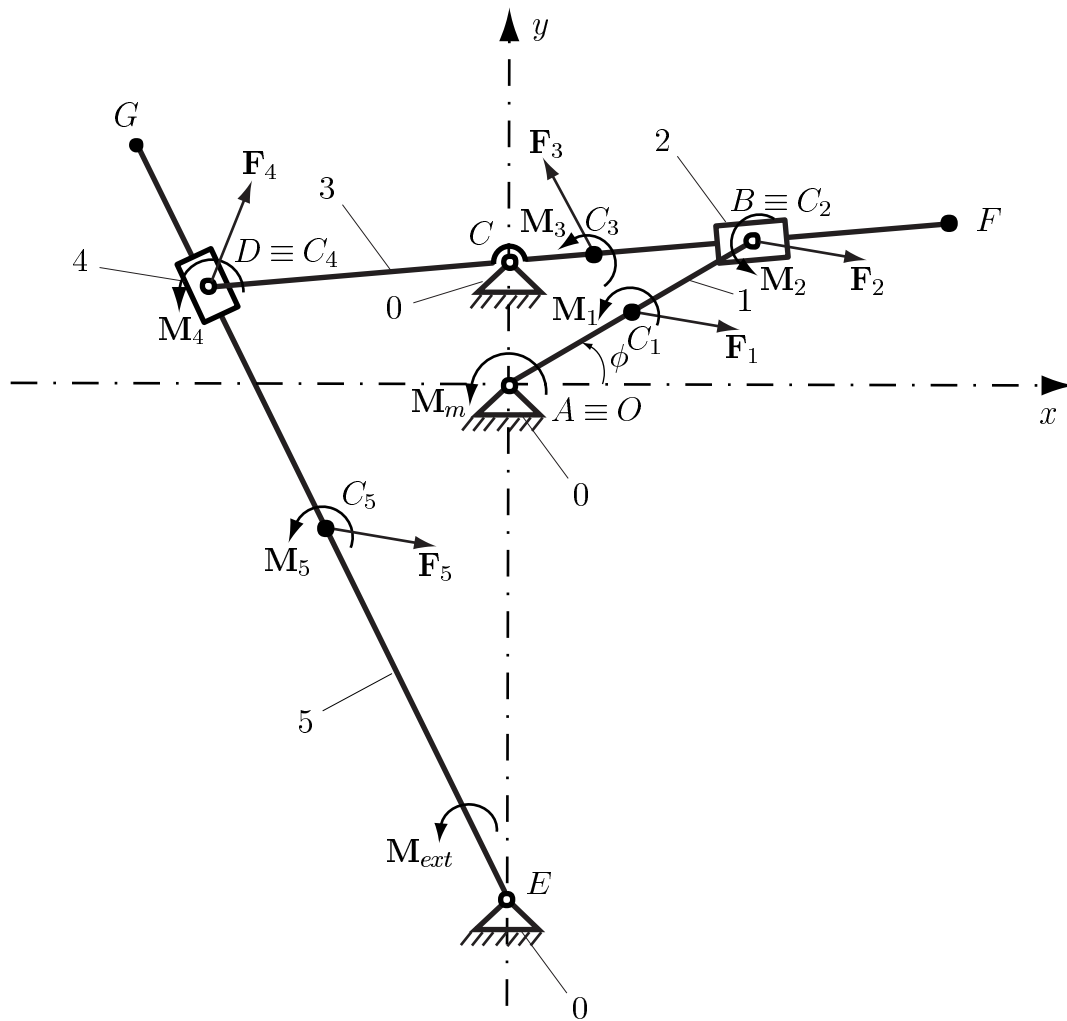

Fig.13

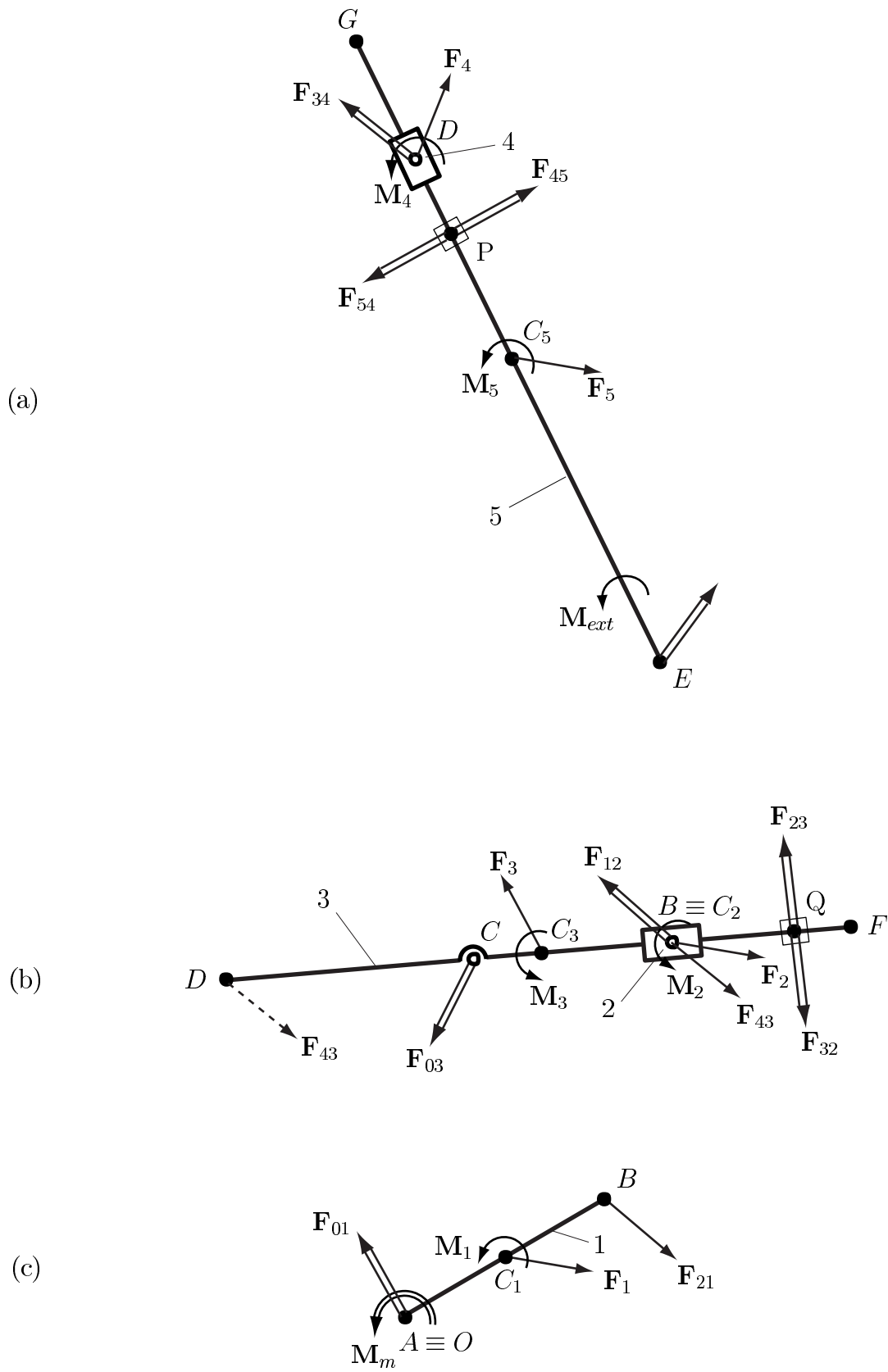

Fig. 14