

Fig. 1

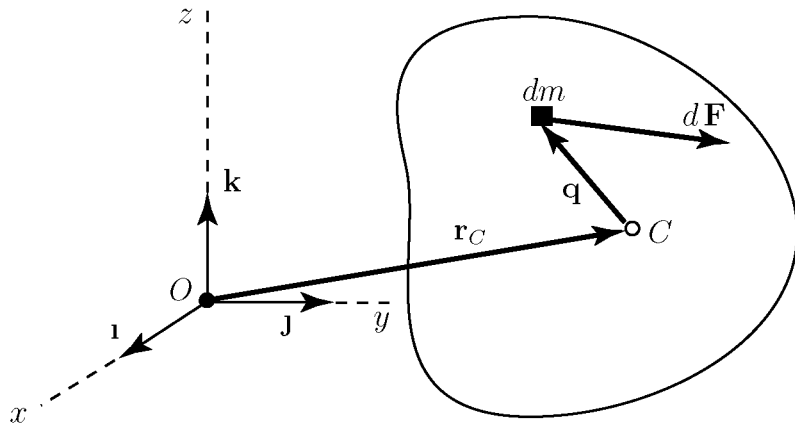

Fig. 2

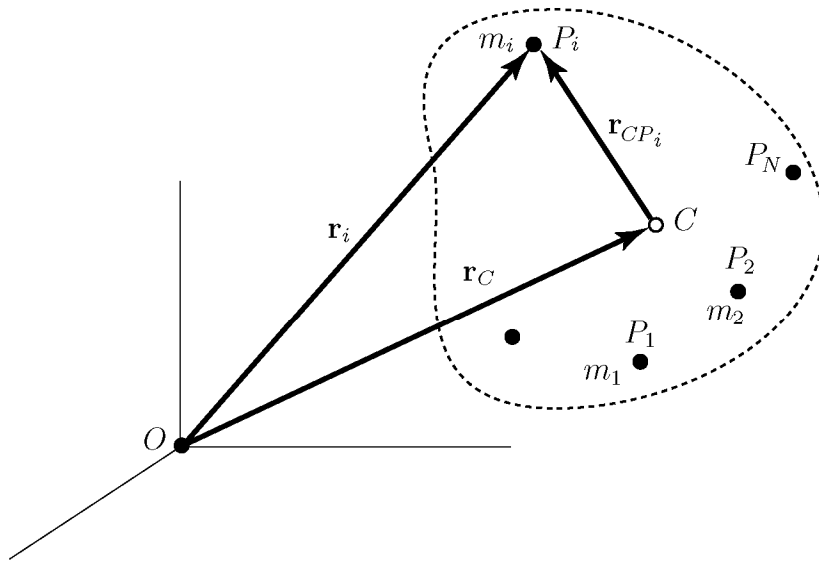

Fig. 3

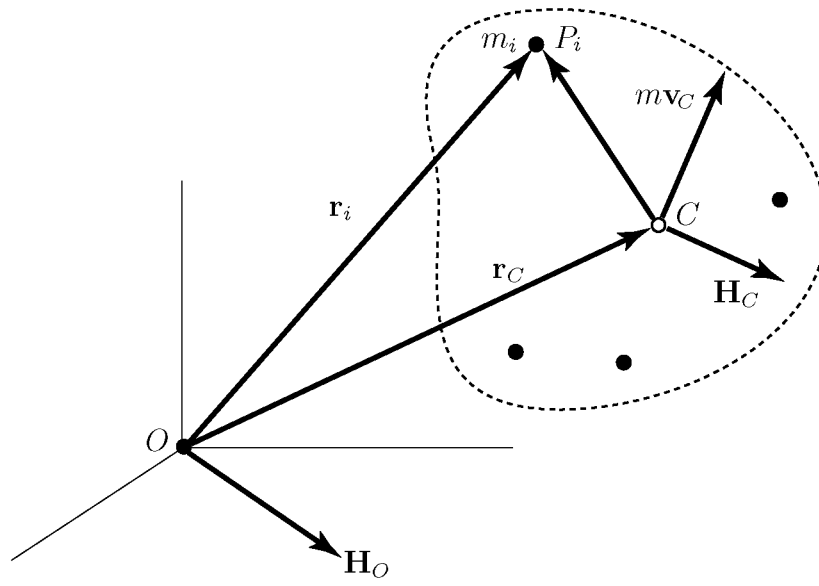

Fig. 4

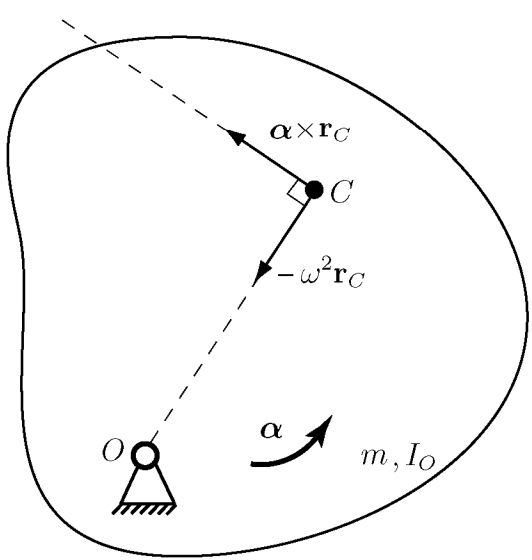
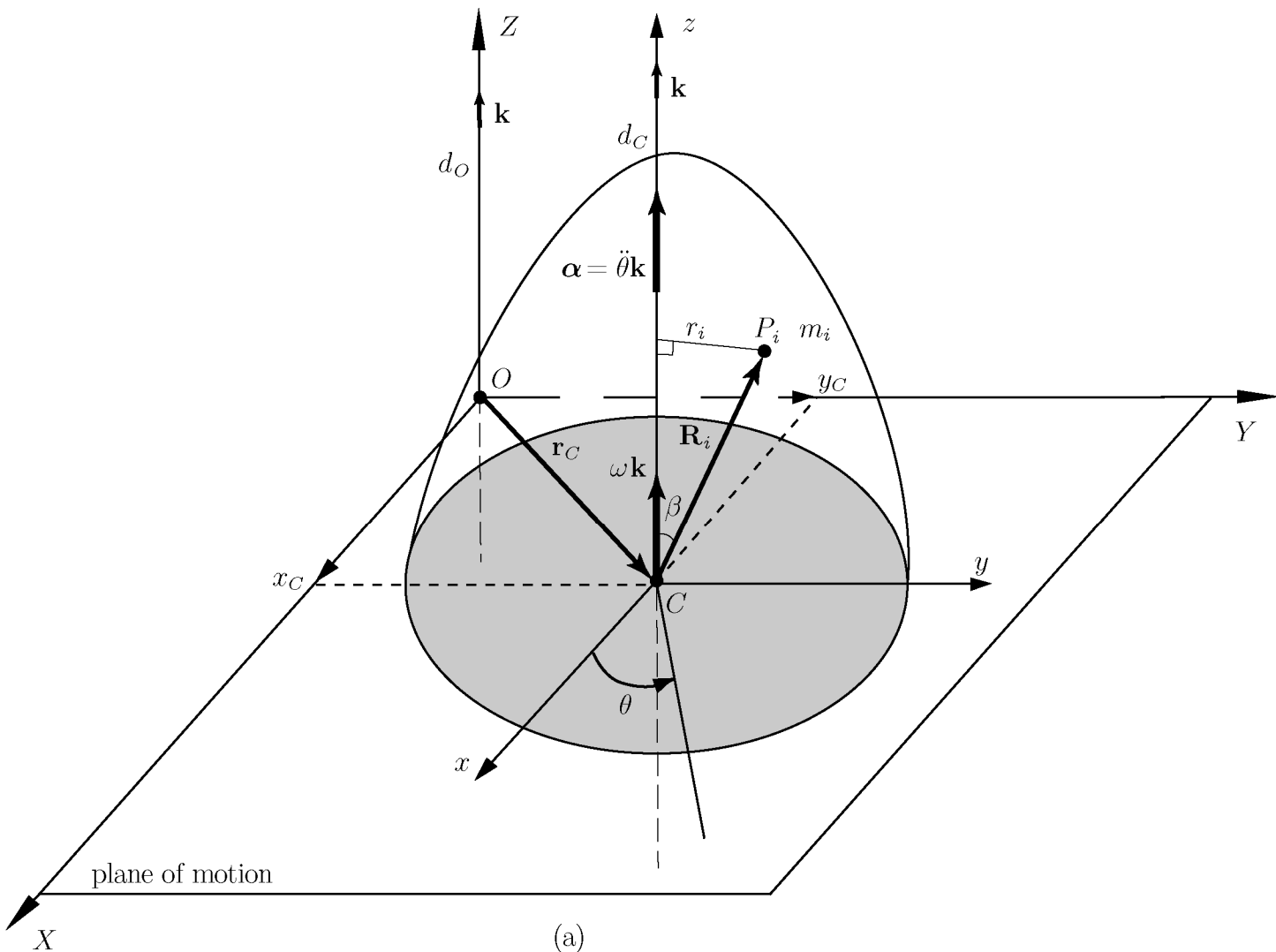

Fig. 5

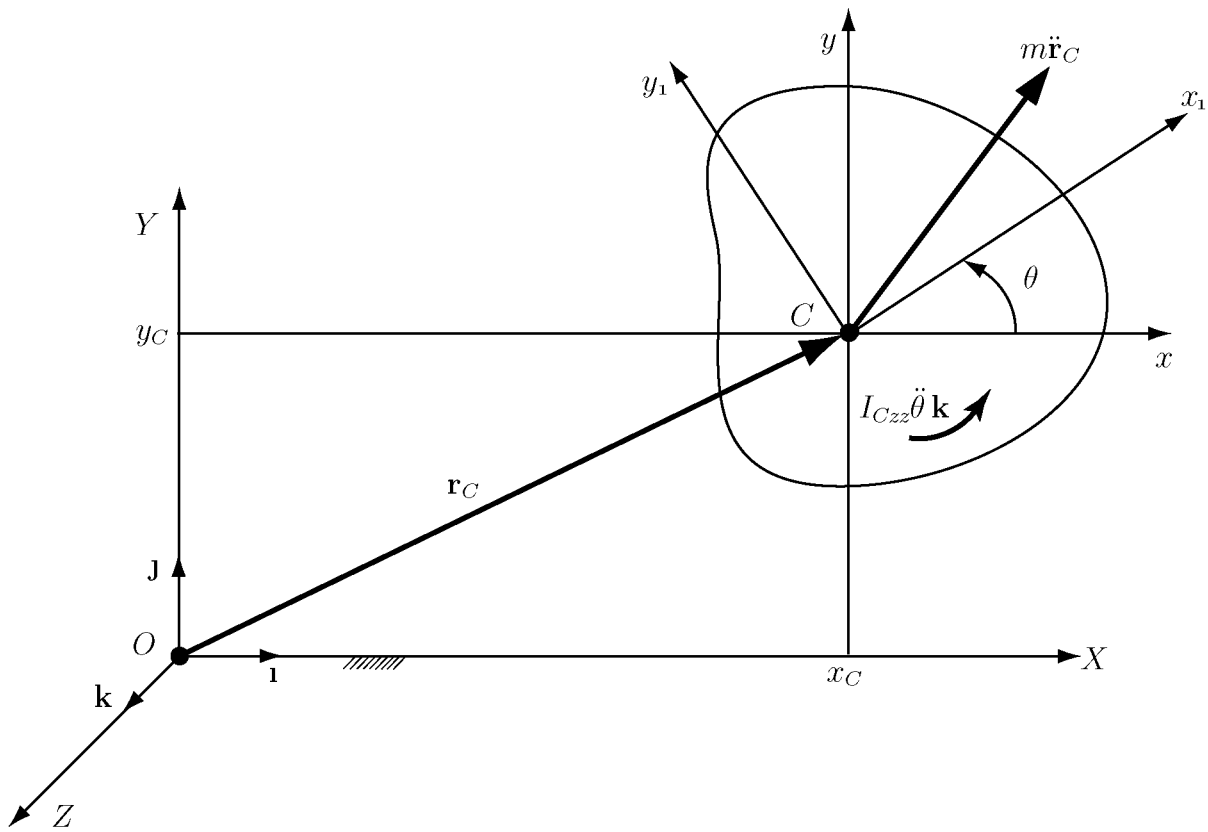
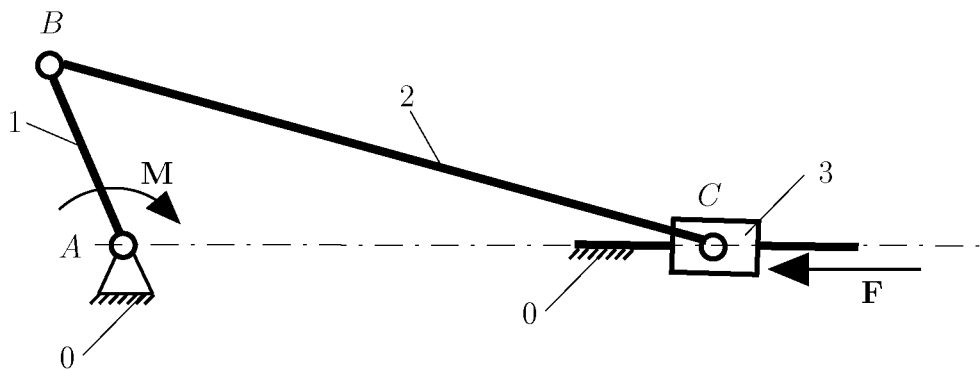
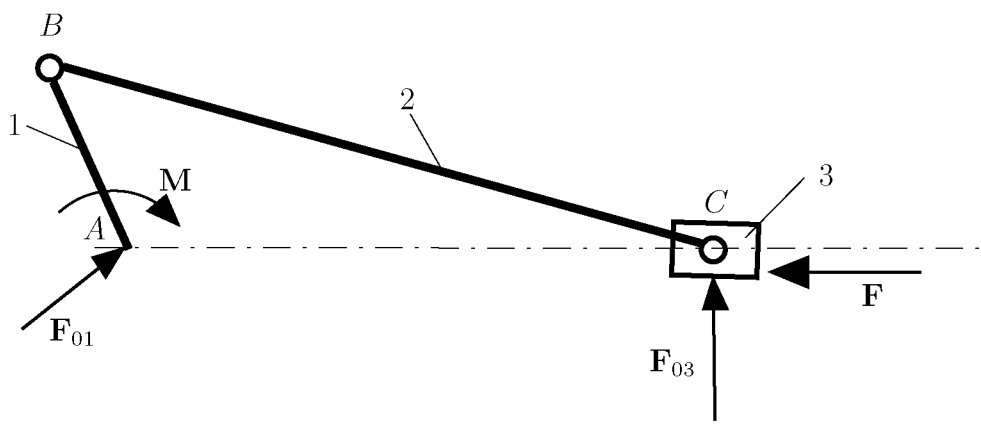

Fig. 6



(a)



(b)

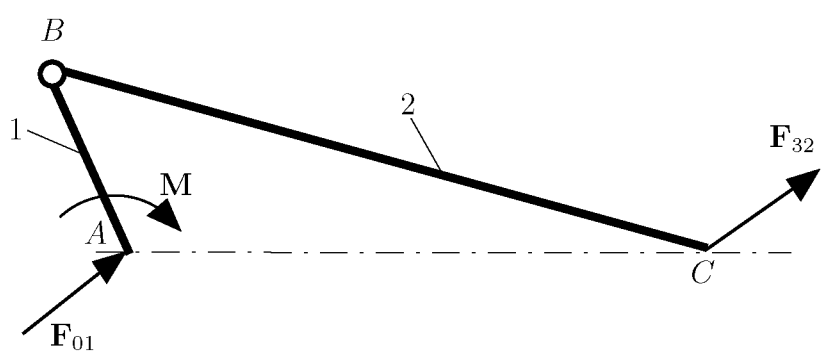

(c)

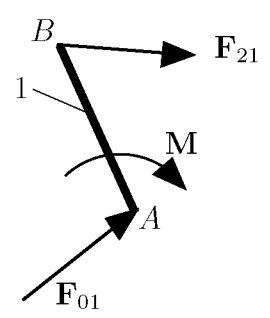

(d)

Fig. 7

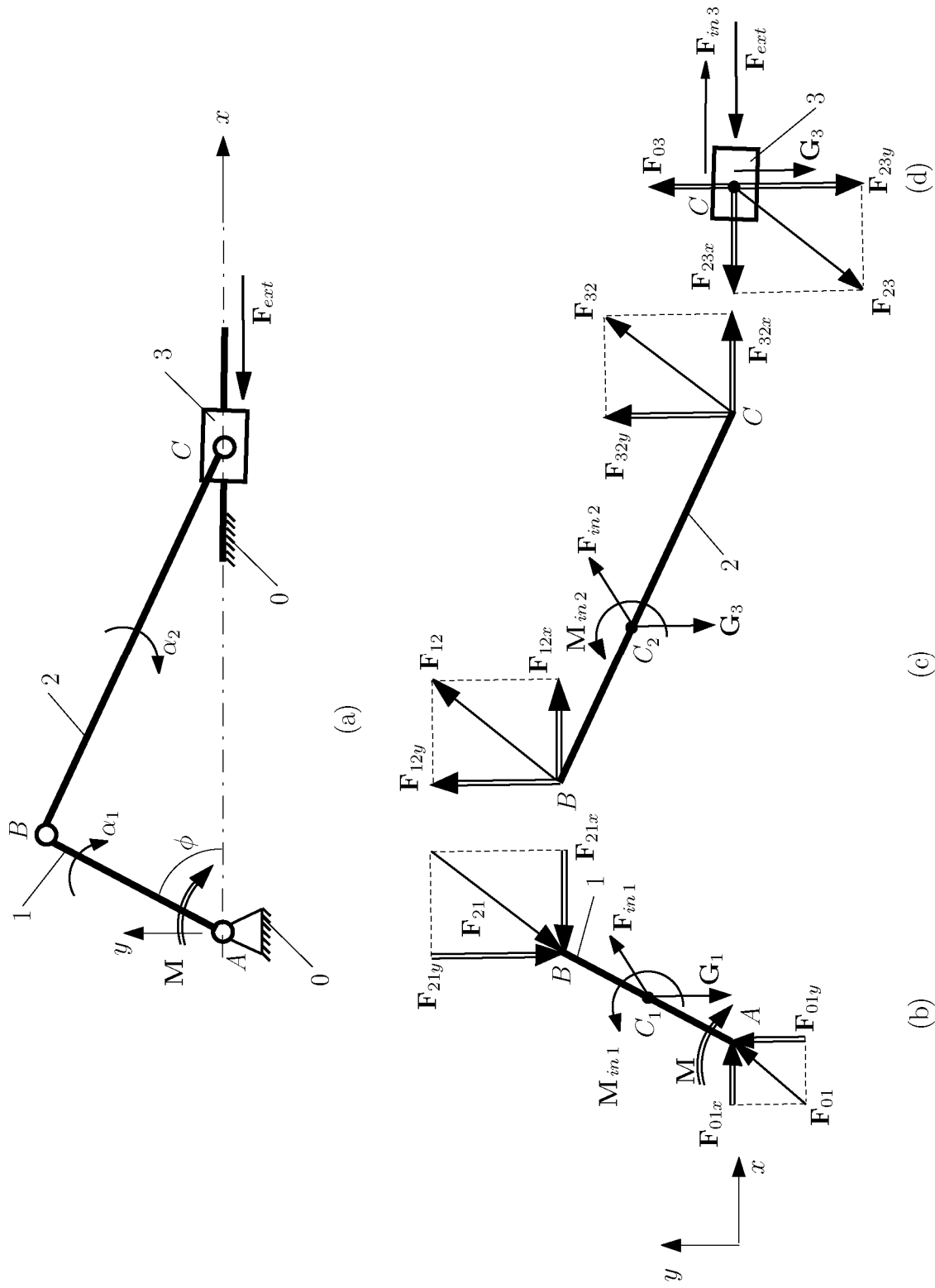
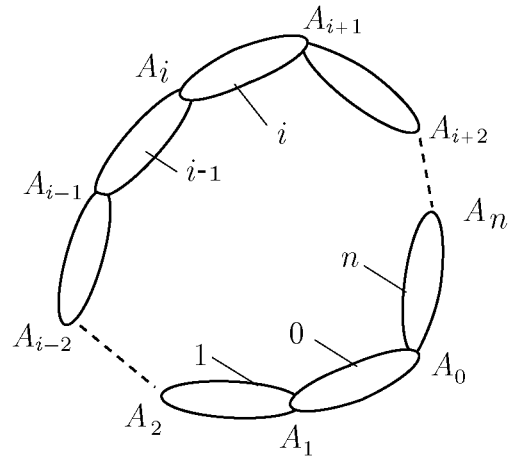
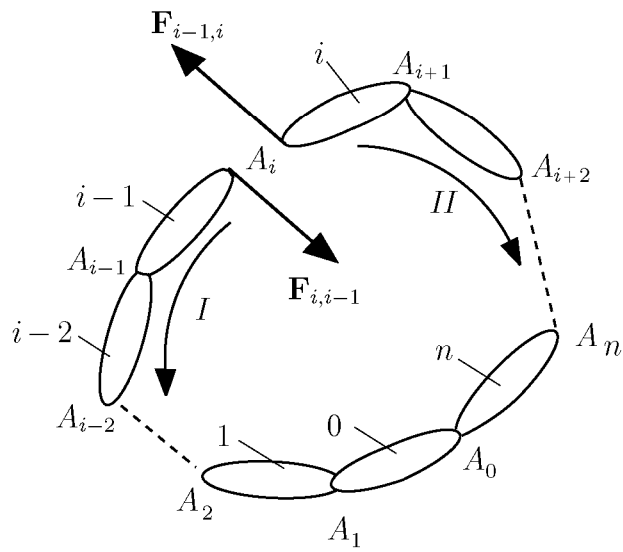

Fig. 8



(a)



(b)

Fig. 9

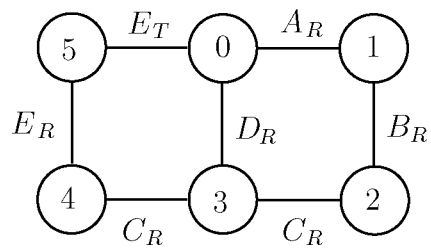

(b)

Fig. 10